



COLORI / COLORS

- 7504** bianco
white
- 7504MT** bianco matt
matt white
- 7504NEMT** nero matt
matt black
- 7504GM** grigio matt
matt grey
- 7504SA** sabbia
sand



Lavabo appoggio o sospeso cm 70x48xh20.
Countertop or wall-hung washbasin cm 70x48xh20.

Kg. 28

ACCESSORI NON INCLUSI / ACCESSORIES NOT INCLUDED

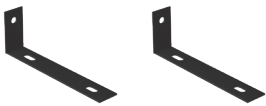

7540 nero
black

Staffa per installazione a parete (x2),
realizzata in acciaio satinato.
Bracket for wall hung installation (x2),
realized in satin stainless steel..



Piletta click-clack o trasformabile sempre
aperta con cover in ceramica.
Click-clack or open drain with ceramic cover.

- | | | |
|---------------------------------------------------------------------------------------------------------------------------------------------------------------------------------------------------------|-----------------------------------------------------------------------------------------------------------------------------------------------------------------------------------------------------------|--------------------------------------------------------------------------------------------------------------------------------------------------------------------------------------------------------------|
| 9916 cromo
chrome | 9916BI bianco
white | 9916BIMT bianco matt
matt white |
| 9916NEMT nero matt
matt black | 9916NE nero lucido
glossy black | 9916GM grigio matt
matt grey |
| 9916PE petrolio
petrol | 9916SA sabbia
sand | 9916OC ocra
ocher |
| 9916SV salvia
sage | 9916VI viola
violet | |

ATTENZIONE/ ATTENTION

Galassia Srl persegue la filosofia di migliorare i prodotti aggiungendo nuovi materiali, innovazioni progettuali e tecnologie produttive. L'azienda si riserva di cambiare

schede tecniche e caratteristiche di funzionamento degli articoli in ogni momento e senza necessità di preavviso. I pesi possono subire variazioni del 20 %

Galassia Srl is constantly improving its products by adding new materials, new projects and modern production technologies. The company reserves the right to change any technical

specifications/dimension and/or operating characteristics of the products at any time and without giving notice. The ceramic items weight may vary up to 20%.

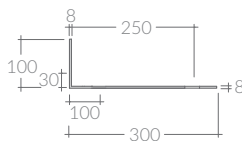
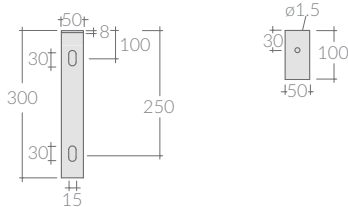
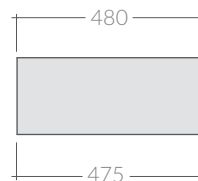
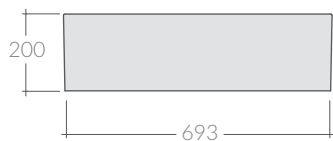
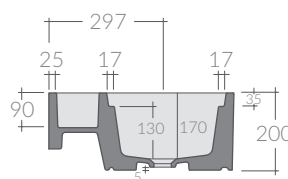
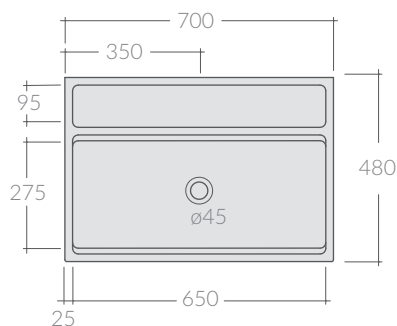

ATTENZIONE/ ATTENTION

Galassia Srl persegue la filosofia di migliorare i prodotti aggiungendo nuovi materiali, innovazioni progettuali e tecnologie produttive. L'azienda si riserva di cambiare

schede tecniche e caratteristiche di funzionamento degli articoli in ogni momento e senza necessità di preavviso. I pesi possono subire variazioni del 20 %

Galassia Srl is constantly improving its products by adding new materials, new projects and modern production technologies. The company reserves the right to change any technical

specifications/dimension and/or operating characteristics of the products at any time and without giving notice. The ceramic items weight may vary up to 20%.